

# SMV-90M82 (90mm F3.5)

## ► Lens Dimension

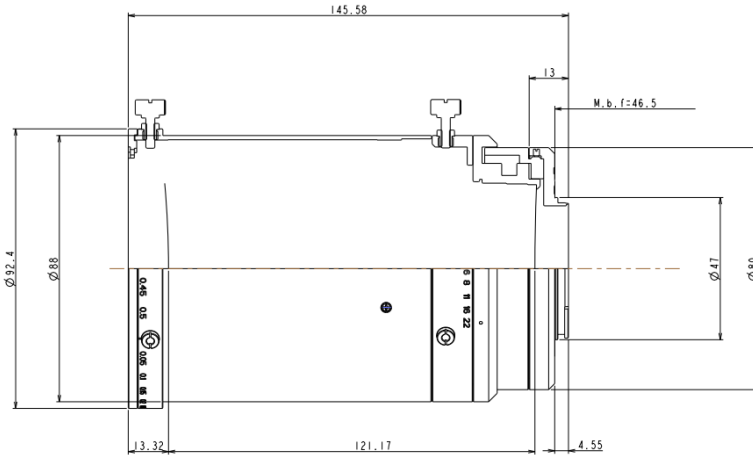

## ► Technical Specification

Focal Length (mm)		90					Aperture		F3.5 ~ F22			
Working Distance (Min. ~ Max / mm)		225 ~ 1853					Flange back (mm)		46.5(F), 31.8 / 19.56 / 13.14/12/10.1/ 6.56 (M72), 9.4(M95)			
Image Circle (mm)		82					Filter Size (Φ)		67			
Magnification		0.55x ~ 0.05x					Diameter Max (Φ)		92.4			
Mag. (x)	0.05	0.10	0.15	0.20	0.25	0.30	0.35	0.40	0.45	0.50	0.55	
W.D (mm)	1853	954	655	506	417	357	315	284	260	241	225	

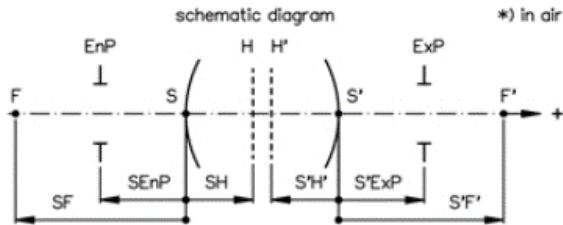

SF (mm)	-57.0	F-stop	ØEnP	ØExP
S'F' (mm)	53.1	3.5	25.80	23.65
HH' (mm)	51.2	4.0	22.51	20.58
SH (mm)	33.0	5.6	16.1	14.8
S'H' (mm)	-36.9	8	11.3	10.3
SEnP (mm)	37.8	11	8.2	7.5
S'ExP (mm)	-29.4	16	5.6	5.2
		22	4.1	3.8

### ▶ MTF Charts

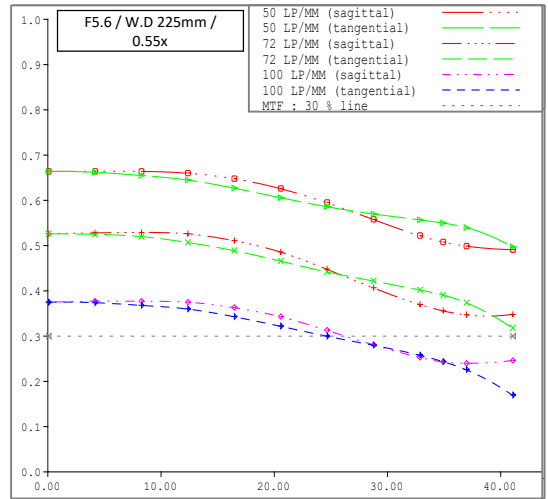
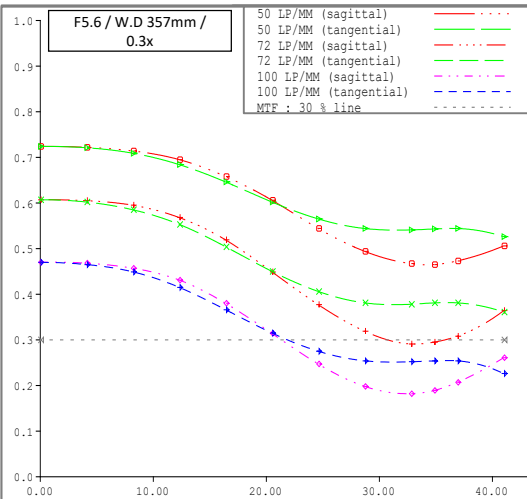
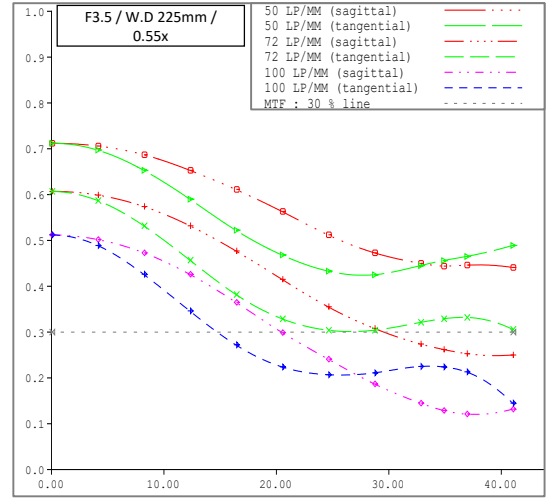
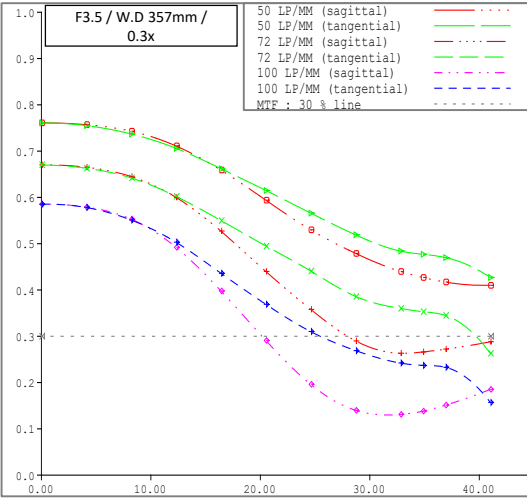

### ▶ Distortion

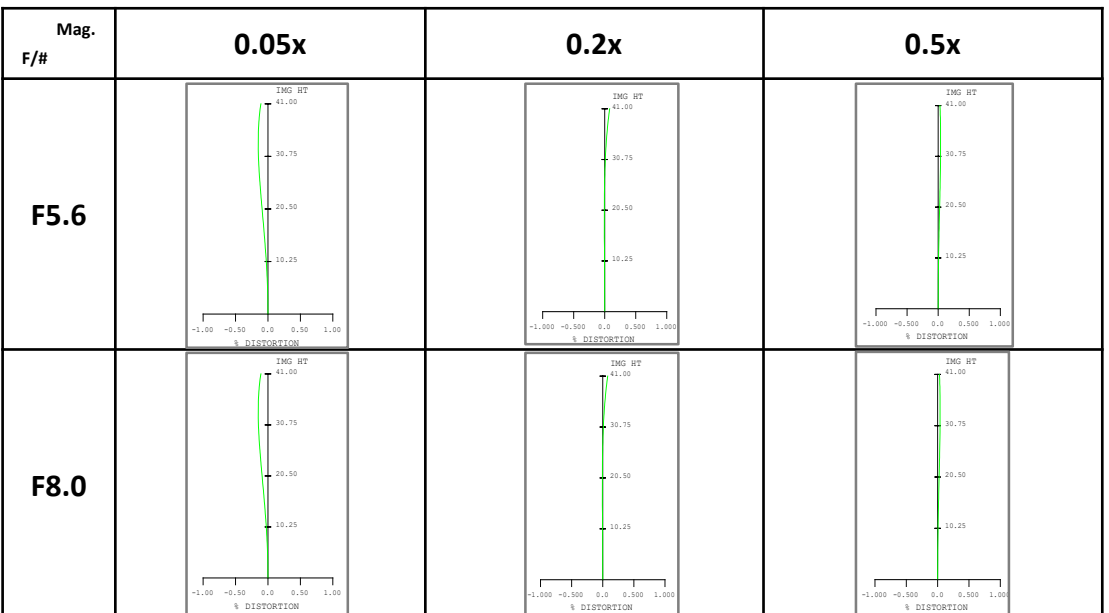

## ► Color Shift (Chromatic focal Shift)

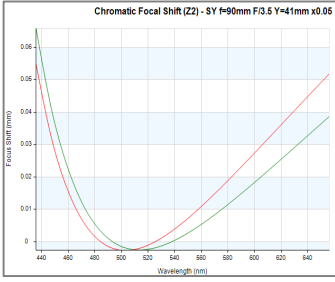

[F5.6 / 0.05X]

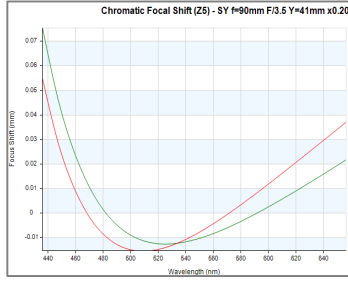

[F5.6 / 0.2X]

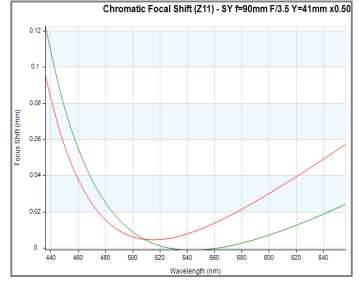

[F5.6 / 0.5X]

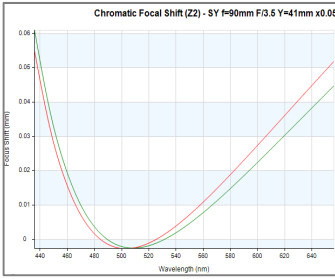

[F8.0 / 0.05X]

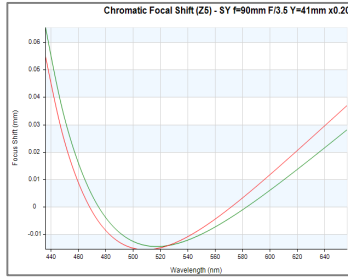

[F8.0 / 0.2X]

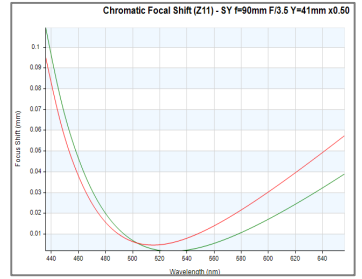

[F8.0 / 0.5X]

## ► Color Shift (Longitudinal Aberration)

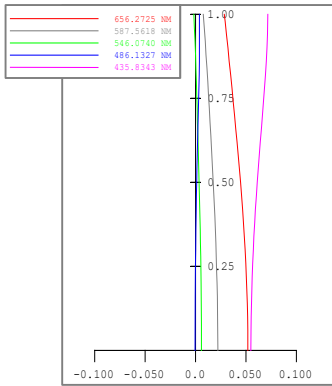

[F5.6 / 0.05X]

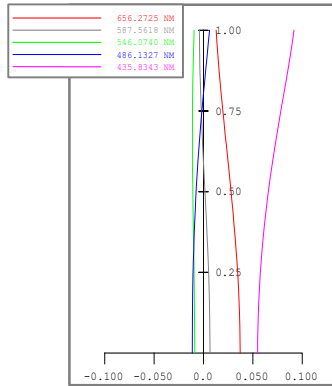

[F5.6 / 0.2X]

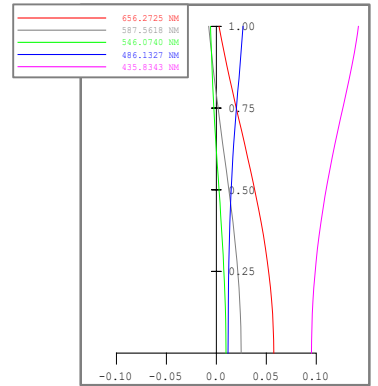

[F5.6 / 0.5X]

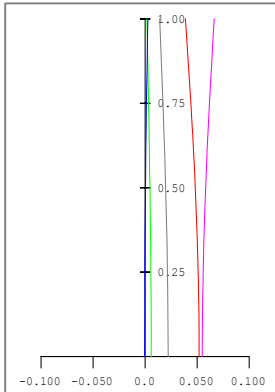

[F8.0 / 0.05X]

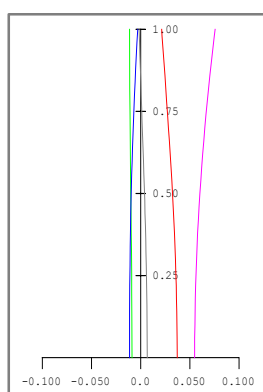

[F8.0 / 0.2X]

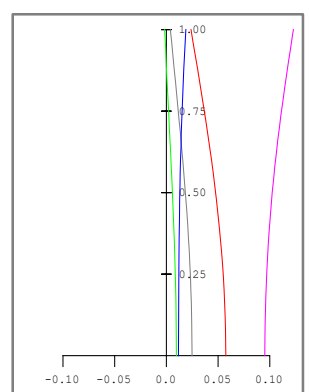

[F8.0 / 0.5X]

## ► Color Shift (Chromatic focal Shift)

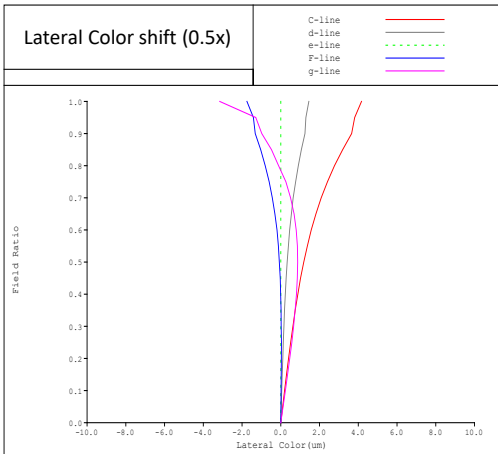
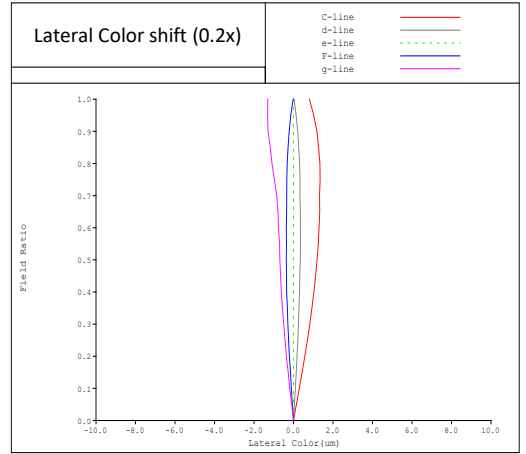
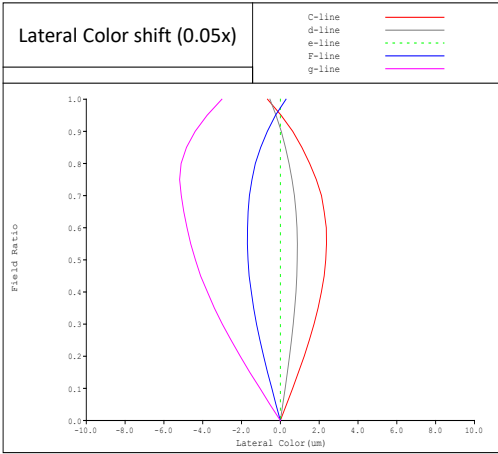

## ► Transmittance

